



OMT3-IE3 225M-4 45kW 400/690V 50Hz , . #

**DATASHEET**

50Hz |

Frame type:	cast iron	Connection:	Δ/Y
Model:	OMT3-IE3	Run Capacitor:	
Output:	45 kW	Start Capacitor:	
Rated voltage:	400/690V	Rotor voltage:	
Frame:	225 mm	Rotor connection:	
Poles:	4	Rotor current:	
Frequency:	50 Hz	No load current:	
Rated speed:	1485 RPM	Insulation class:	F
Rated current:	80,2/46,5 A	Temp. rise:	80 K
Locked rotor current(Ia/In):	740%	Service factor:	1
Locked rotor torque(Ma/Mn):	200%	Duty:	S1
Breakdown torque(Ma/Mn):	230%	Amb. temp.:	-20~40 °C
Mounting:	B3	Altitude:	1000 m
Noise level:	78 dB	Protection:	IP55
Approx. weight:	373 kg	Cooling:	IC411
Mom. of inertia:	0,6117765 kg/m2	Vibration:	2,2 mm/s
Slip:	1%	Dir. rotation:	BOTH
Rated torque:	289 Nm	Starting method:	DIRECT ON LINE
		Coupling:	DIRECT
		Load type:	PARABOLIC CURVE

**PERFORMANCE**

<b>Output</b>	<b>50%</b>	<b>75%</b>	<b>100%</b>
Efficiency(%):	93,4	94,6	94,3
Power factor:			0,86

**BEARING**

	<b>NDE</b>	<b>DE</b>
Bearing	6313 C3	6313 C3
Regreasing int(h):	4000	4000
Grease amount(g):	24	24
Grease polyrexEM:	Caltex SRI-2	Caltex SRI-2

**STANDARDS**

Specification:	IEC60034-1/GB755
Test:	IEC60034-2/GB/T1032
Noise	IEC60034-9/GB10069.3
Vibration:	IEC60034-14/GB10068

**ACCESSORIES**

PTC 150°C

There may be differences between rating plate and calculated values

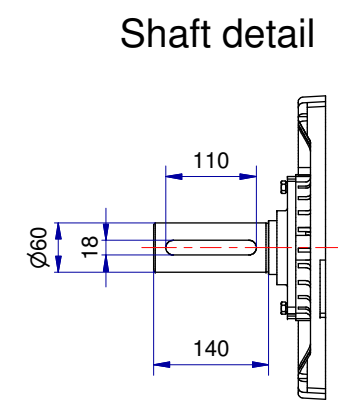
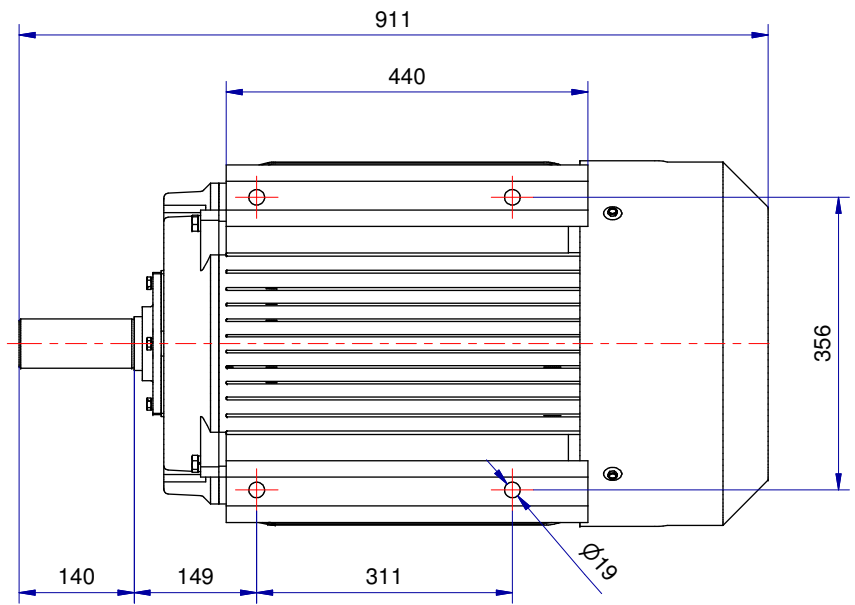
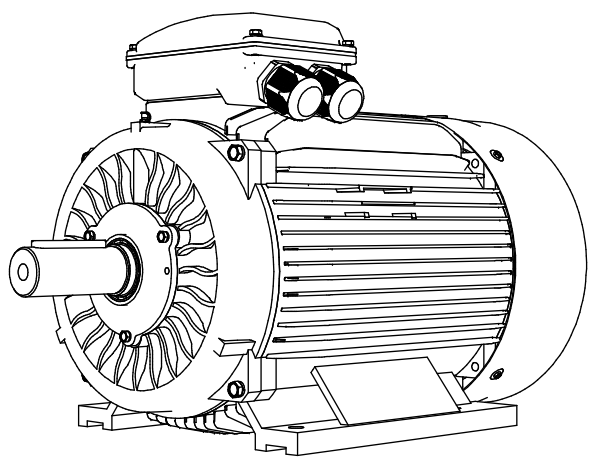
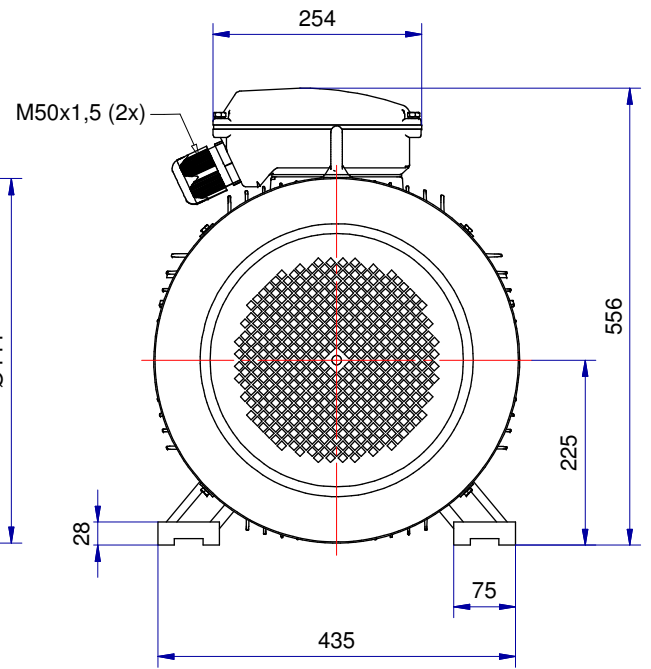
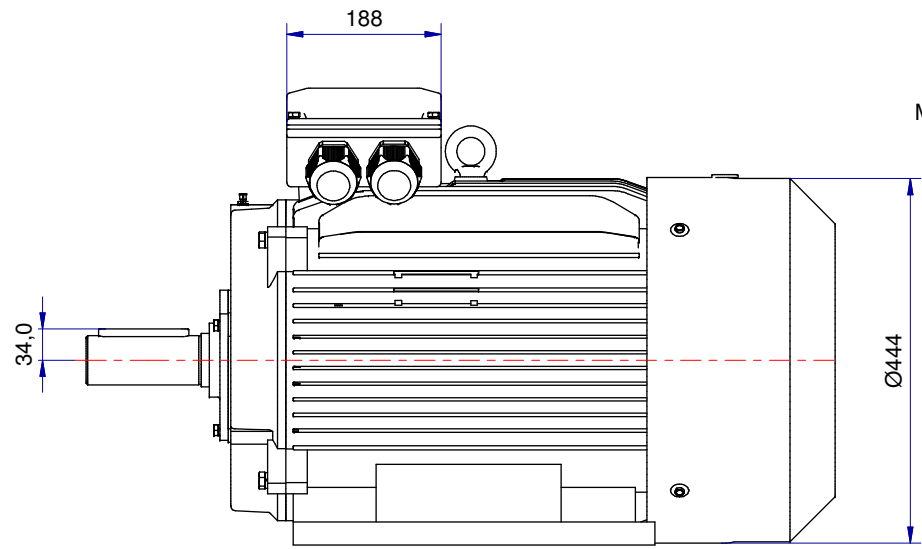
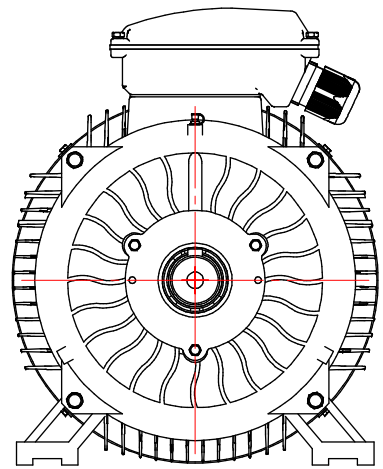

03-IP55-Cast Iron-IE3-225M B3-4\_8